

Green Pin® EE Swivel  
 Group : G-7713  
 Part : WTGPOO22  
 WLL : 4.54t

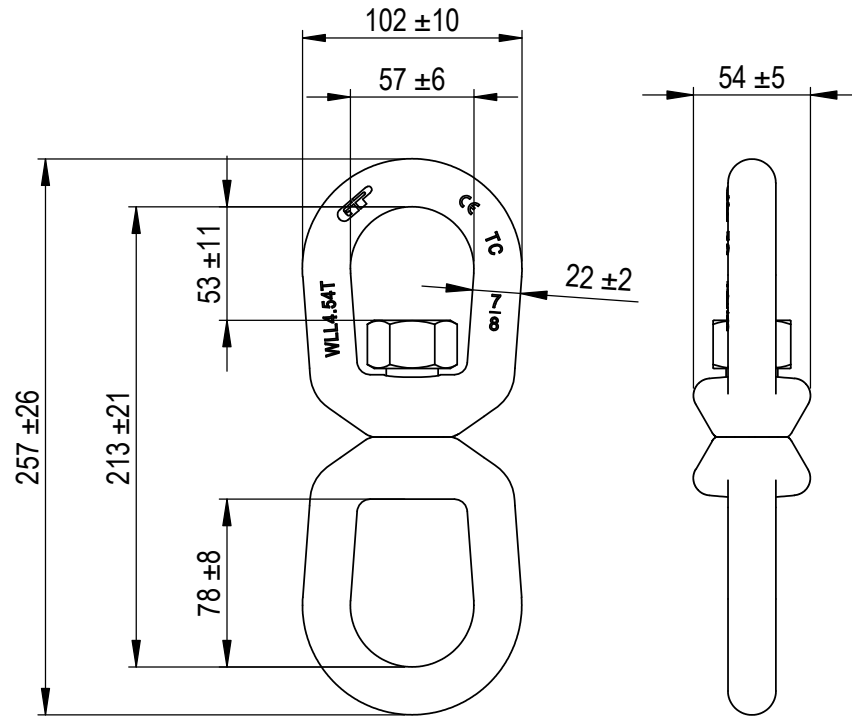

Rev.	Description	Date	Drawn
A	drawing updated	2023/2/15	DL
0	First Issue	2022/1/1	DL



**Green Pin®**  
 P.O. Box 57, 3360 AB Sliedrecht (The Netherlands)  
 Industrieweg 6, 3361 HJ Sliedrecht  
 Tel. +31(0)184-413300 www.greenpin.com

Copyright by Van Beest B.V. moreover this document is the property of Van Beest B.V. This document or any part of it may neither be made known, copied or multiplied, nor used for any purpose other than that for which it is specifically furnished, without the prior written consent of Van Beest B.V.

Title **Green Pin® EE Swivel**  
**Swivel with eye-eye end-fittings**

Remark  
 G-7713  
 WTGPOO22

Format	A4	
Scale	1:3.5	
Drawing number	5806	Rev. A

We reserve the right to make amendments on specifications in this drawing without prior notification.